

Steve's Tech Resource

The Web Development, Internet, Software, Hardware, and Multimedia Resource

[View Posts By Date](#)[FORUM](#)[ALL BOARDS](#)[ABOUT](#)[WHAT'S NEW](#)[HTML AND CSS CODING](#)[SEARCH POSTS](#)[SIGN IN](#)

Interpreting The Windows XP/Vista/7 Notification Area Network Icon

 [Original](#) | [No Header, No Background, No Images](#)

[For: Windows XP](#) | [Windows Vista](#) | [Windows 7](#)

Last Updated: 04Apr11 | Published: 08Dec10 | Status: To Be Continued

1. [Introduction](#)
2. [Fully Enabling The Windows XP/Vista Notification Area Network Icon](#)
 - 2.1. [Fully Enabling The Windows XP Notification Area Network Icon: Show In Notification Area When Connected](#)
 - 2.2. [Fully Enabling The Windows Vista Notification Area Network Icon: Turn On Activity Animation](#)
3. [Interpreting The Windows XP Notification Area Network Icon](#)
 - 3.1. [The Windows XP Notification Area Network Icon: Local Area Connection - A Network Cable Is Unplugged](#)
 - 3.2. [The Windows XP Notification Area Network Icon: Local Area Connection - Status: Limited Or No Connectivity](#)
 - 3.3. [The Windows XP Notification Area Network Icon: Local Area Connection - Status: Connected](#)
4. [Interpreting The Windows Vista Notification Area Network Icon](#)
 - 4.1. [The Windows Vista Notification Area Network Icon: Not Connected - You Are Currently Not Connected To Any Networks](#)
 - 4.2. [The Windows Vista Notification Area Network Icon: Currently Connected To: Unidentified Network - Access: Limited Connectivity](#)
 - 4.3. [The Windows Vista Notification Area Network Icon: Currently Connected To: Network - Access: Local Only](#)
 - 4.4. [The Windows Vista Notification Area Network Icon: Currently Connected To: Network - Access: Local And Internet](#)
5. [Interpreting The Windows 7 Notification Area Network Icon](#)
 - 5.1. [The Windows 7 Notification Area Network Icon: Not Connected - No Connections Are Available](#)
 - 5.2. [The Windows 7 Notification Area Network Icon: Unidentified Network - No Network Access](#)
 - 5.3. [The Windows 7 Notification Area Network Icon: Network - No Internet Access](#)
 - 5.4. [The Windows 7 Notification Area Network Icon: Network - Internet Access](#)

1. Introduction

The Windows XP, Windows Vista, and Windows 7 (Windows XP/Vista/7) notification area Network icon provides network status and diagnostic information through icon overlays and icon mouseover infotips. The Windows XP/Vista/7 notification area Network icon is a valuable tool for detecting and diagnosing network connection issues.



This page assumes your computer obtains its IP address from your Internet Service Provider (ISP) or router. In other words, this page assumes your computer network adapter's TCP/IPv4 and TCP/IPv6 properties are set to Obtain an IP address automatically, which is the Windows XP/Vista/7 default.

2. Fully Enabling The Windows XP/Vista Notification Area Network Icon

By default, the Windows 7 notification area Network icon is fully enabled and the Windows XP/Vista notification area Network icon is not fully enabled.

2.1. Fully Enabling The Windows XP Notification Area Network Icon: Show In Notification Area When Connected

By default, the Windows XP notification area Network icon is shown when the network has limited or no connectivity, and is not shown when the network is connected. To show the Windows XP notification area Network icon when the network is connected:

1. Click **Start | Control Panel | Network and Internet Connections | Network Connections**.
2. Right click the **Local Area Connection** corresponding to your network adapter (not 1394 Connection, if present) and select **Properties**.
3. Check **Show icon in notification area when connected**.

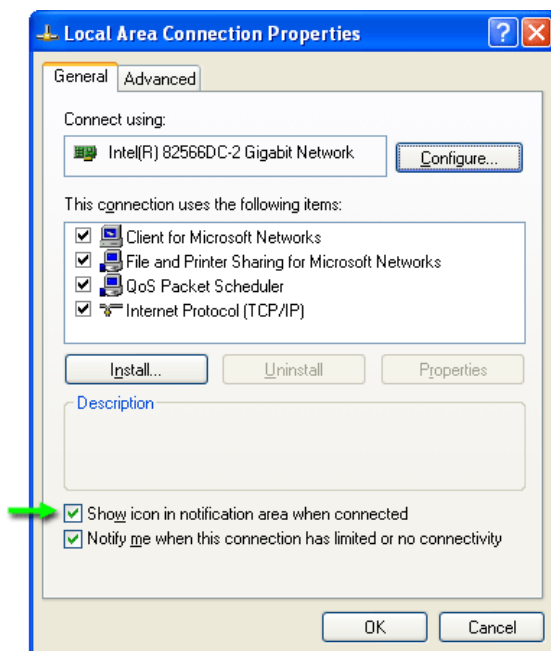

4. Click **OK**.

2.2. Fully Enabling The Windows Vista Notification Area Network Icon: Turn On Activity Animation

Unlike Windows 7, the Windows XP/Vista notification area Network icon animates (i.e., the icon's monitors light up) when network activity occurs (i.e., the computer is sending/receiving network data). By default, the Windows Vista notification area Network icon activity animation is turned off. To turn on the Windows Vista notification area Network icon activity animation:

- Right click the **notification area Network icon** and select **Turn on activity animation**.

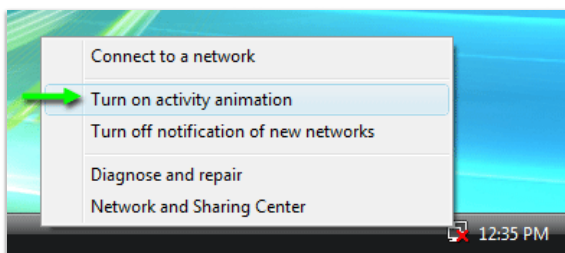

3. Interpreting The Windows XP Notification Area Network Icon

i

- Unlike Windows 7, the Windows XP notification area Network icon animates (i.e., the icon's monitors light up) when the computer is sending/receiving network data.
- Unlike Windows Vista/7, the Windows XP notification area Network icon does not distinguish between the presence or absence of an Internet connection.

3.1. The Windows XP Notification Area Network Icon: Local Area Connection - A Network Cable Is Unplugged

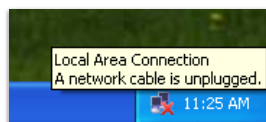

This Network icon appears when the cabling between the computer and the network device is faulty or the network device is powered off:

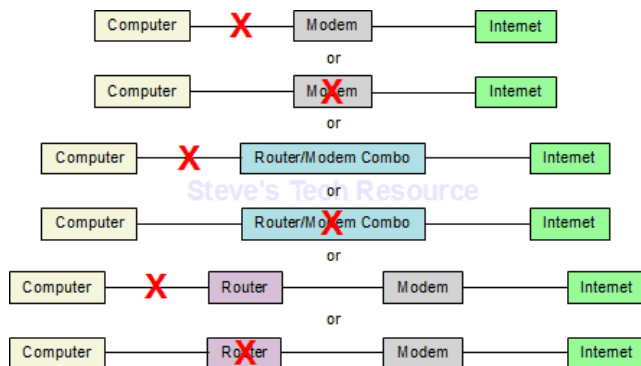

3.2. The Windows XP Notification Area Network Icon: Local Area Connection - Status: Limited Or No Connectivity

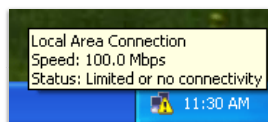

This Network icon appears when the computer finds a network device and is unable to obtain an IP address. With a routerless (i.e., direct) network connection, this occurs when the modem needs to be powered off/on or reset, the connection between the modem and the Internet is faulty, or the Internet is down. With a router, this occurs when the router needs to be powered off/on or reset:

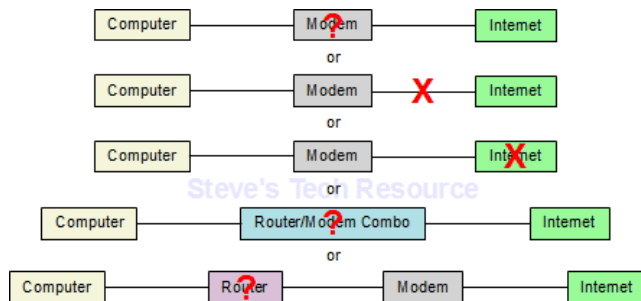

3.3. The Windows XP Notification Area Network Icon: Local Area Connection - Status: Connected

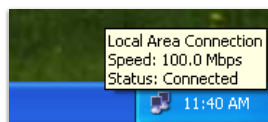

When the computer is sending/receiving network data the Network icon lights up:

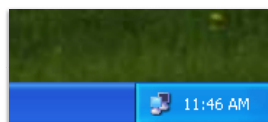

This Network icon appears when the computer finds a network device and obtains an IP address:

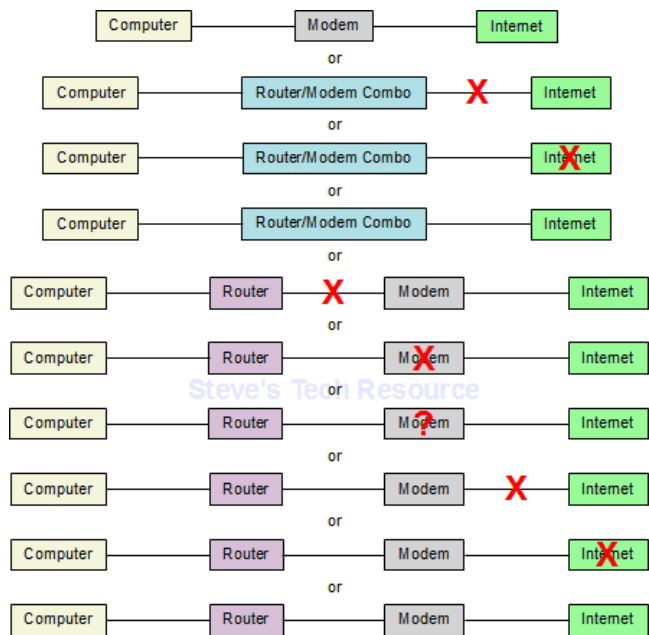

4. Interpreting The Windows Vista Notification Area Network Icon

- Unlike Windows 7, the Windows Vista notification area Network icon animates (i.e., the icon's monitors light up) when the computer is sending/receiving network data.
- Unlike Windows XP, the Windows Vista notification area Network icon distinguishes between the presence or absence of an Internet connection.
- With a functioning routerless (i.e., direct) network connection, the Network icon mouseover infotip reference to "Local" is misleading.

4.1. The Windows Vista Notification Area Network Icon: Not Connected - You Are Currently Not Connected To Any Networks

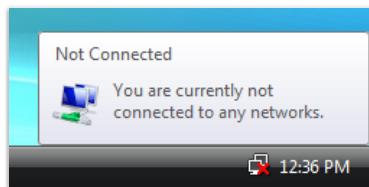

This Network icon appears when the cabling between the computer and the network device is faulty or the network device is powered off:

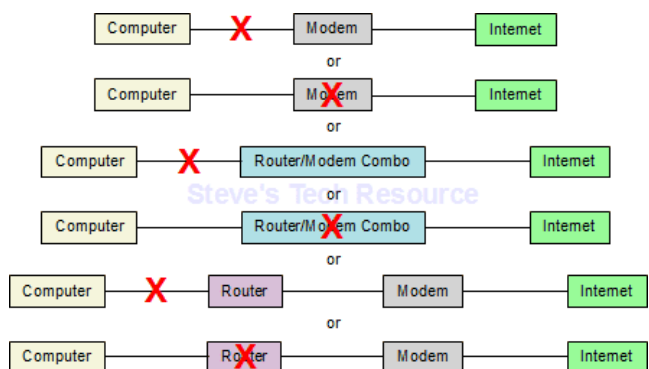

4.2. The Windows Vista Notification Area Network Icon: Currently Connected To: Unidentified Network - Access: Limited Connectivity

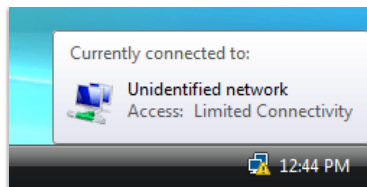

This Network icon appears when the computer finds a network device and is unable to obtain an IP address. With a routerless (i.e., direct) network connection, this occurs when the modem needs to be powered off/on or reset, the connection between the modem and the Internet is faulty, or the Internet is down. With a router, this occurs when the router needs to be powered off/on or reset:

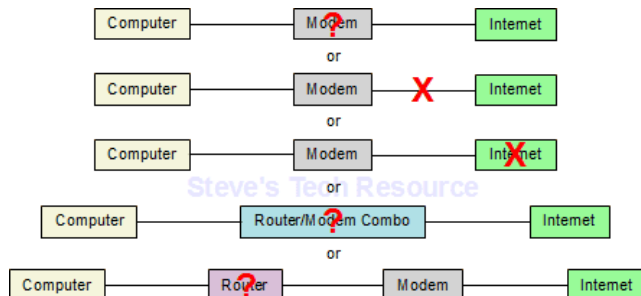

4.3. The Windows Vista Notification Area Network Icon: Currently Connected To: Network - Access: Local Only

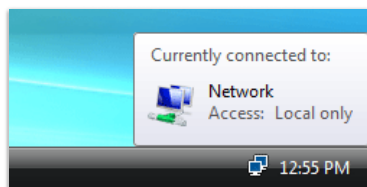

When the computer is sending/receiving network data the Network icon lights up:

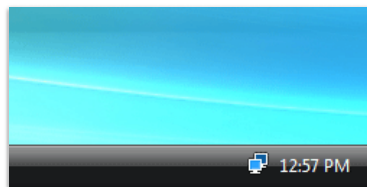

This Network icon appears when the computer finds a network device, obtains an IP address, and is unable to connect to the Internet. This only occurs with a router and when something on the WAN (i.e., public) side of the router is not functioning, including when the cabling is faulty, the modem is powered off, the modem needs to be powered off/on or reset, or the Internet is down:

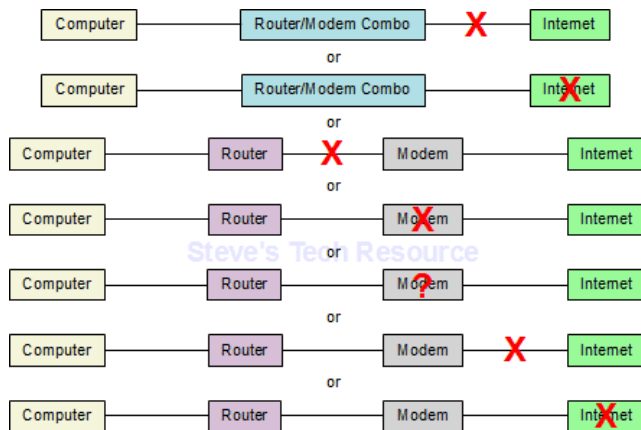

4.4. The Windows Vista Notification Area Network Icon: Currently Connected To: Network - Access: Local And Internet

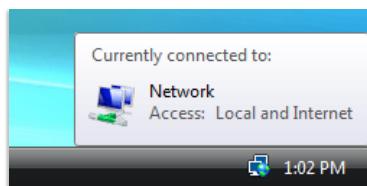

When the computer is sending/receiving network data the Network icon lights up:

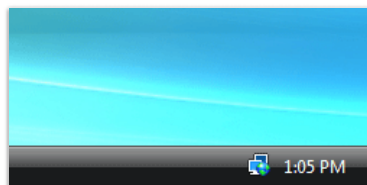

This Network icon appears when the computer finds a network device, obtains an IP address, and connects to the Internet:

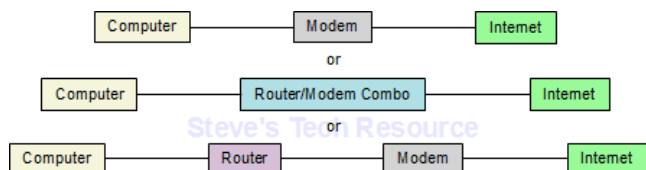

5. Interpreting The Windows 7 Notification Area Network Icon

i

- Unlike Windows XP/Vista, the Windows 7 notification area Network icon does not animate (i.e., the icon's monitors do not light up) when the computer is sending/receiving network data.
- Unlike Windows XP, the Windows 7 notification area Network icon distinguishes between the presence or absence of an Internet connection.
- The Windows 7 notification area Network icon is identical for "Unidentified network - No network access" and "Network - No internet access."

5.1. The Windows 7 Notification Area Network Icon: Not Connected - No Connections Are Available



This Network icon appears when the cabling between the computer and the network device is faulty or the network device is powered off:

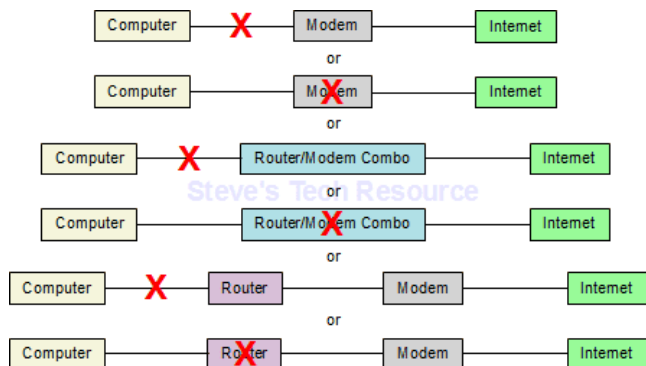

5.2. The Windows 7 Notification Area Network Icon: Unidentified Network - No Network Access

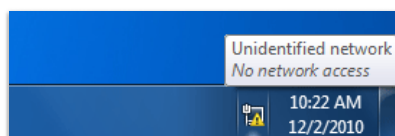

This Network icon appears when the computer finds a network device and is unable to obtain an IP address. With a routerless (i.e., direct) network connection, this occurs when the modem needs to be powered off/on or reset, the connection between the modem and the Internet is faulty, or the Internet is down. With a router, this occurs when the router needs to be powered off/on or reset:

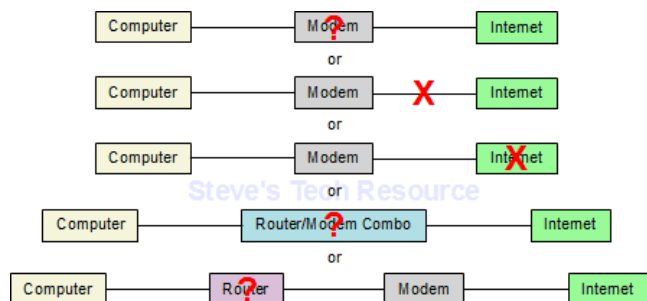

5.3. The Windows 7 Notification Area Network Icon: Network - No Internet Access

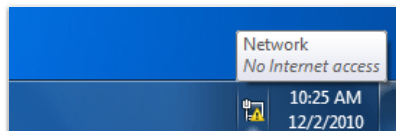

This Network icon appears when the computer finds a network device, obtains an IP address, and is unable to connect to the Internet. This only occurs with a router and when something on the WAN (i.e., public) side of the router is not functioning, including when the cabling is faulty, the modem is powered off, the modem needs to be powered off/on or reset, or the Internet is down:

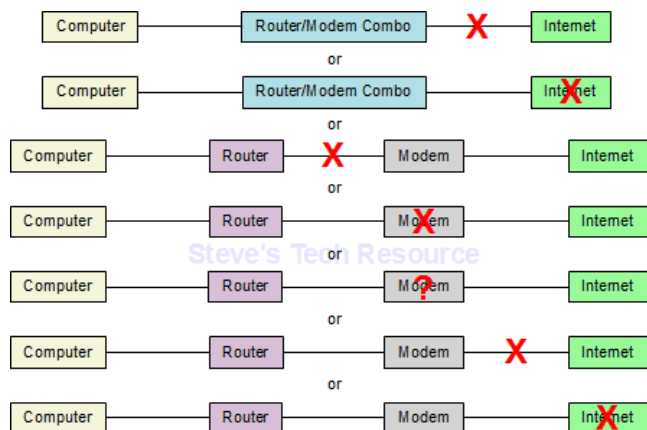

5.4. The Windows 7 Notification Area Network Icon: Network - Internet Access

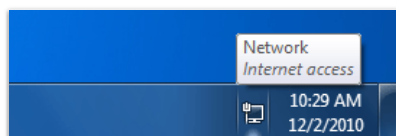

This Network icon appears when the computer finds a network device, obtains an IP address, and connects to the Internet:

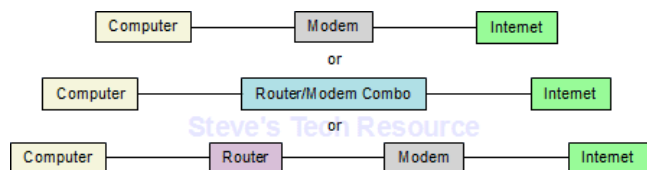

Steve's Tech Resource

The Web Development, Internet, Software, Hardware, and Multimedia Resource



Copyright © 2000-2012 Steve's Tech Resource